

TM-533-T/R

TACT Switch



Features

- Sharp click feel with a positive tactile feed-back. Due to small movement distance (stroke), user experiences distinct sensation when the switch clicks into place
- Ultraminiature and light weight structure suitable for high density mounting. Economic but high reliability
- Insert moulding in the contact with special treatment prevents flux build-up during soldering and permits auto-dipping

TM- 533

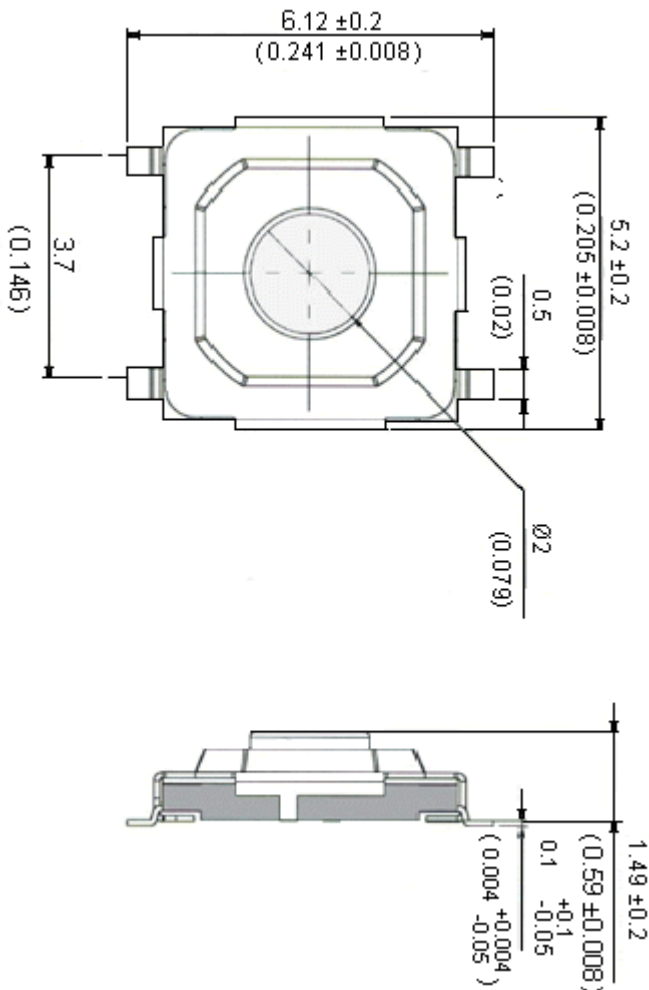

General Tolerance: ± 0.2 mm (± 0.008 inches)

Dimensions : Millimetres (Inches)

TM-533-T/R

TACT Switch



Circuit Diagram

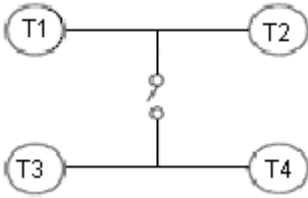

PCB Layout

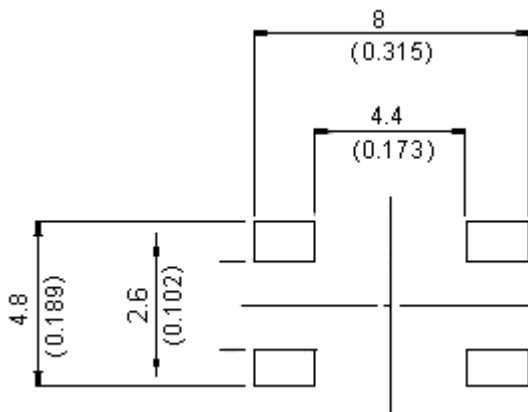

Materials

Cover	: Stainless steel
Contact Disc	: Phosphor bronze with silver cladding
Terminal	: Brass with silver cladding
Base	: LCP High-temperature thermoplastic Colour : Black
Stem	: Brass

Specifications

Mechanical

Operation Force	: 160 ±50 gf
Stop Strength	: Place the switch such that vertical, a static load of 3 kgf shall be applied in the direction of stem operation for a period of 15 seconds
Stroke	: 0.25 (+0.2 mm / -0.1 mm)
Operating Temperature Range	: -25°C to +70°C
Storage Temperature Range	: -30°C to +80°C
Vibration Test	: MIL-STD-202F Method 201 A Frequency : 10 - 55 - 10 Hz/1 minute Directions : X, Y, Z, three mutually perpendicular directions Time : 2 hours each direction High reliability

TM-533-T/R



TACT Switch

Specifications

Mechanical

Shock Test : MIL-STD-202F Method 213B
Condition A
Gravity : 50 G (peak value), 11 milliseconds
Direction and times : 6 sides and 3 times in each direction
High reliability

Electrical

Electrical Life : 300,000 cycles minimum
Contact Resistance : 100 mΩ maximum
Insulation Resistance : 100 mΩ minimum at 500 V dc
Dielectric Strength : 250 V ac/1 minute
Contact Arrangement : 1 Pole 1 throw

Soldering Process

Wave Soldering : Recommended solder temperature at 500°F (260°C) maximum 5 seconds subject to PCB 1.6 mm thickness. (Soldering for through hole type)
Hand Soldering : Use a soldering iron of 30 watts, controlled at 608°F (320°C) approximately 2 seconds while applying solder
Soldering : Vapour phase and IR-reflow soldering can be applied
Condition for Soldering (Reflow and non-washable type)

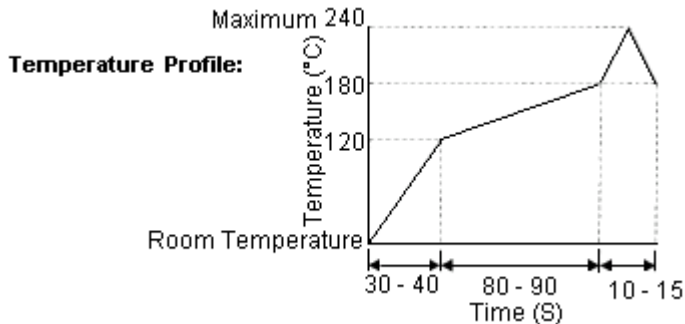

Part Number Table

Description	Part Number
TACTILE SWITCH, SPNO, SMD	TM-533I-Q-T/R

Item	Description	Materials	Treatment	Remarks
1	Stem	SPCC-SD	Ni Plating	-
2	Cover	□ = Nickel Silver S = Stainless Steel	□ = None S = With Silver Plating	-
3	Adhesive Tape	Teflon	None	-
4	Terminal	Phosphor Bronze	With Silver Plating	-
5	Contact	Stainless Steel	With Silver Cladding	-
6	Base	High – Temperature Thermoplastic LCP	Moulded Black	-

TM-533-T/R



TACT Switch

Part Number Explanation:

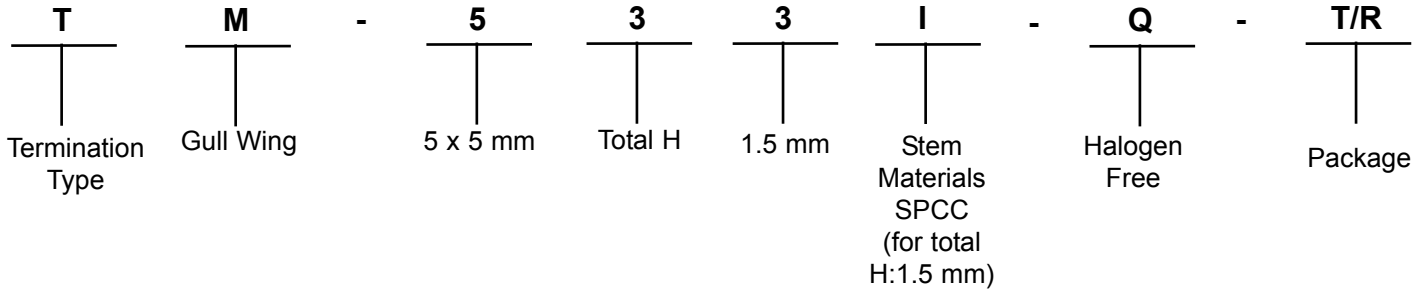

Termination Type:

M = Gull Wing

Total Height : 3 = 1.5 mm

Operating Force : 3 = 160 g

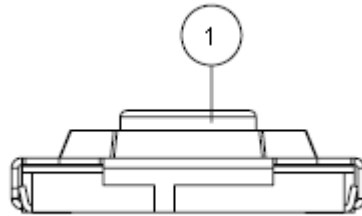
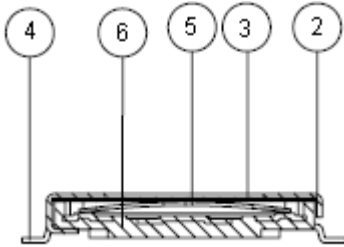

Important Notice : This data sheet and its contents (the "Information") belong to the members of the Premier Farnell group of companies (the "Group") or are licensed to it. No licence is granted for the use of it other than for information purposes in connection with the products to which it relates. No licence of any intellectual property rights is granted. The Information is subject to change without notice and replaces all data sheets previously supplied. The Information supplied is believed to be accurate but the Group assumes no responsibility for its accuracy or completeness, any error in or omission from it or for any use made of it. Users of this data sheet should check for themselves the Information and the suitability of the products for their purpose and not make any assumptions based on information included or omitted. Liability for loss or damage resulting from any reliance on the Information or use of it (including liability resulting from negligence or where the Group was aware of the possibility of such loss or damage arising) is excluded. This will not operate to limit or restrict the Group's liability for death or personal injury resulting from its negligence. Multicomp is the registered trademark of the Group. © Premier Farnell plc 2011.