

5W HI-POWER LED SPECIFICATION

HPR8C-49K5xWFx

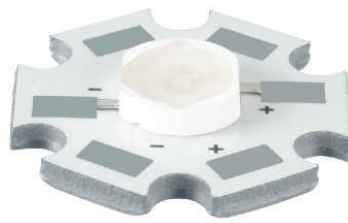

Drawn by	Checked by	Approved by



DATE:2009/11/9

REV:B

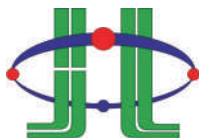

HUEY JANN ELECTRONICS INDUSTRY CO., LTD.

No.27 Line 466 Sec.2,Cannng-nan Rd. Wu-chi Town Taichung Shien, Taiwan, R.O.C.

TEL:+886-4-26393976 FAX:+886-4-26393125

HUEY JANN High Power 5W LED is made of GaInN chips with precise package technique which makes excellent heat dissipation to reach the advantages of high luminous efficiency, low decay, and long endurance. Now we have these colors available: red, green, blue, white, yellow and infrared.

FEATERUS

- Instant light
- Long operating life
- Superior ESD defense
- Low voltage DC operated
- More energy efficient than incandescent and most halogen lamps

TYPICAL APPLICATIONS

- Architectural detail lighting
- Portable flashlight
- Medical applications
- Beacon lights
- Decoration lights
- Spotlight

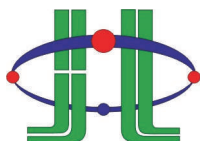

HUEY JANN ELECTRONICS INDUSTRY CO., LTD.

No.27 Line 466 Sec.2,Cannng-nan Rd. Wu-chi Town Taichung Shien, Taiwan, R.O.C.

TEL:+886-4-26393976 FAX:+886-4-26393125

Explanation of Part Number:

H P R 8 C - 4 9K 5 xWF / WPCB
① ② ③ ④ ⑤ ⑥ ⑦ ⑧ ⑨ ⑩

1.H: Huey Jann

2.P: High power LED Type

3.Shape distinguish:

B: Lambertian type S: Side emitting type
D: Focusing type E: Focusing type
R: Reflector type

4.Identification no:

5.Lead frame type

6.Appearance:

4:White Diffusion

7.Color number:

3K: Green 4K: Yellow
5K: Red 8K: Blue
9K: White

8.Power type:

Non: 1W 05: 0.5W
3: 3W 5: 5W

9.Color kind:

WF: Pure White
YWF(4000°K): Nature White
YWF: Warm White

10.Heat conduction type:

Non: emitter type
/WPCB: with white star type heat sink

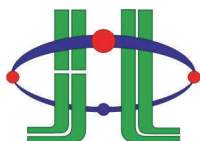

HUEY JANN ELECTRONICS INDUSTRY CO., LTD.

No.27 Line 466 Sec.2,Cannng-nan Rd. Wu-chi Town Taichung Shien, Taiwan, R.O.C.

TEL:+886-4-26393976 FAX:+886-4-26393125

DEVICES

Emitter Type

Item	Lens Color	Dice Source	Color
HPR8C-49K5WF	White Diffused	GaN/GaN	Pure White
HPR8C-49K5YWF(4000°K)			Nature White
HPR8C-49K5YWF			Warm white

With White Star MCPCB Type

Item	Lens Color	Dice Source	Color
HPR8C-49K5WF/WPCB	White Diffused	GaN/GaN	Pure White
HPR8C-49K5YWF/WPCB(4000°K)			Nature White
HPR8C-49K5YWF/WPCB			Warm white

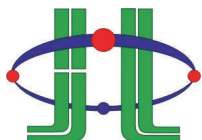

HUEY JANN ELECTRONICS INDUSTRY CO., LTD.

No.27 Line 466 Sec.2,Cannng-nan Rd. Wu-chi Town Taichung Shien, Taiwan, R.O.C.

TEL:+886-4-26393976 FAX:+886-4-26393125

PACKAGE DIMENSIONS:

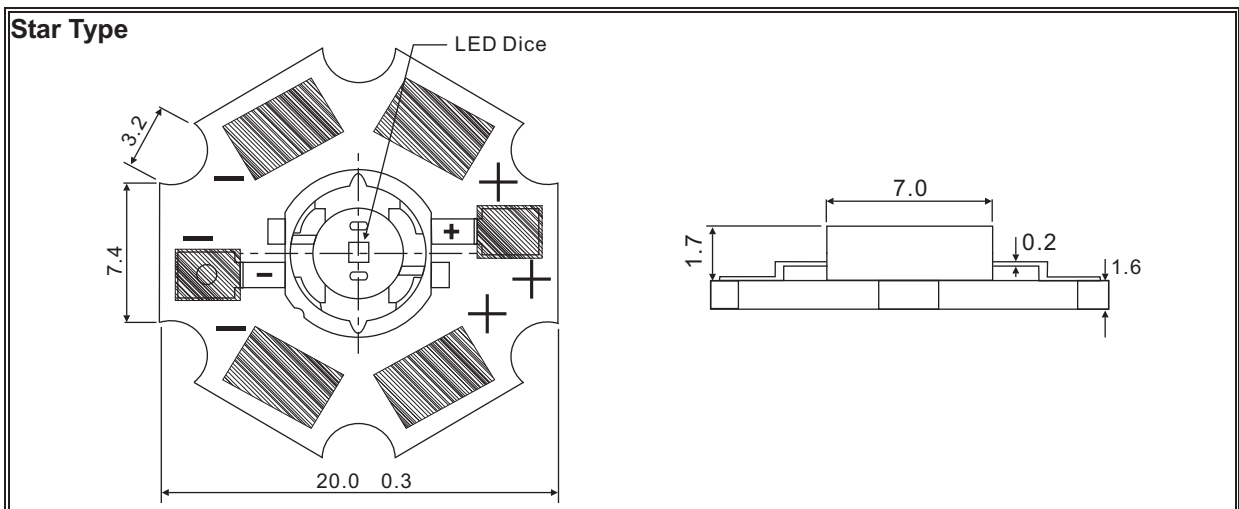
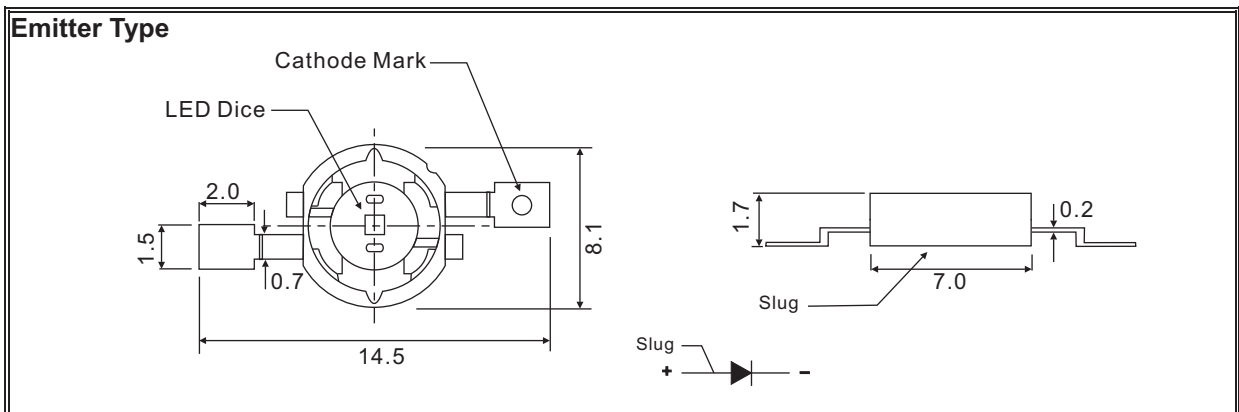

NOTE:

- 1.All dimensions are in millimeter.
- 2.Lead spacing in measured where the lead emerge from the package.
- 3.prodruded resin under flange is 1.5mm max.
- 4.specifications are subject to change without notice.
- 5.Tolerance is 0.3mm unless otherwise noted.
- 6.Driving LED without heat sinking device is forbidden.
- 7.It is strongly recommended that the temperature of lead be not higher than 55°C.
- 8.Proper current derating must be observed to maintain junction temperature below the maximum.
- 9.LEDs are not designed to be driven in reserve bias.

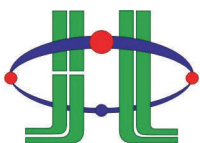

HUEY JANN ELECTRONICS INDUSTRY CO., LTD.

No.27 Line 466 Sec.2,Cann-g-nan Rd. Wu-chi Town Taichung Shien, Taiwan, R.O.C.

TEL:+886-4-26393976 FAX:+886-4-26393125

ABSOLUTE MAXIMUM RATINGS

TA=25°C

PARAMETER	SYMBOL	MAX. RATING	UNIT
Continuous Forward Current	IF	1400	mA
Peak Forward Current *1	IFM	1500	mA
Electrostatic Discharge(HBM)	ESD	4000	V
LED Junction Temperature	Tj	135	°C
Operating Temperature	Topr	-40 ~ +110	°C
Storage Temperature	Tstg	-40 ~ +120	°C
Reflow Soldering (preheat 150-180°C 60-120sec, soldering temp 260°C 10sec)			

*1.Duty Ratio=0.1%,Pulse Width=10us.

*2.Iron soldering high temperature will not cause damage to the dice. But be aware of the high temperature will not only make the epoxy soften but also cause the lead moving and the gold wire broken and even open. So before returning to the normal temperatures PLEASE AVOID any serious pressure on the top of epoxy and lead.

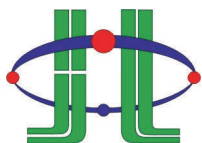

HUEY JANN ELECTRONICS INDUSTRY CO., LTD.

No.27 Line 466 Sec.2,Cannng-nan Rd. Wu-chi Town Taichung Shien, Taiwan, R.O.C.

TEL:+886-4-26393976 FAX:+886-4-26393125

ELECTRIC-OPTICAL CHARACTERISTICS

TA=25°C

PARAMETER	SYMBOL	TEST CONDITION	TYP	MAX	UNIT
View Angle of Half Power	2θ _{1/2}	IF=1400mA	110		deg
Forward Voltage	V _F		3.8	4.3	V
Thermal Resistance Junction To Case	R _{θ J-C}		8		°C/W
Thermal Resistance Junction To Case With Star Type Heat Sink	R _{θ J-C}		11		°C/W
Temperature Coefficient Of Forward Voltage	ΔV _F /ΔT		-2		mV/°C

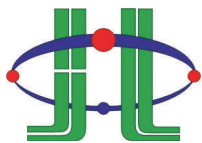

HUEY JANN ELECTRONICS INDUSTRY CO., LTD.

No.27 Line 466 Sec.2,Canng-nan Rd. Wu-chi Town Taichung Shien, Taiwan, R.O.C.

TEL:+886-4-26393976 FAX:+886-4-26393125

ELECTRIC-OPTICAL CHARACTERISTICS FOR LUMINOUS INTENSITY

Emitter Type

TA=25°C

ITEM	SYMBOL	TEST CONDITION	MIN	TYP	UNIT
Pure White	IV	IF=1400mA		262	lm
Nature White				250	
Warm white				232	

*Tolerance: 15% HUEY-JANN measuring equipment : EXELTRON 2001. 2.S370 made by U.D.T.

ELECTRIC-OPTICAL CHARACTERISTICS FOR COLOR TEMPERATURE

Emitter Type

TA=25°C

ITEM	SYMBOL	TEST CONDITION	TYP	UNIT
Pure White	CCT	IF=1400mA	6000	°K
Nature White			4000	
Warm white			3300	

*Tolerance: 15% HUEY-JANN measuring equipment : EXELTRON 2001. 2.S370 made by U.D.T.

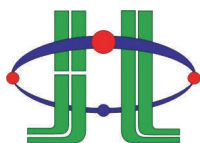

HUEY JANN ELECTRONICS INDUSTRY CO., LTD.

No.27 Line 466 Sec.2,Canng-nan Rd. Wu-chi Town Taichung Shien, Taiwan, R.O.C.

TEL:+886-4-26393976 FAX:+886-4-26393125

RELIABILITY TEST

Endurance Test

Test Item	Reference Standard	Test Conditions	Result
Operation Life	MIL-STD-750:1026 MIL-STD-883:1005 JIS-C-7021 :B-1	Connect with a power if=1400mA Ta=Under room temperature Test Time=1,000hrs	0/22
High Temperature High Humidity Storage	MIL-STD-202:103B JIS-C-7021 :B-11	Ta=+85°C 5°C RH=80% ~ 85% Test Time=1,000hrs	0/22
High Temperature Storage	MIL-STD-883:1008 JIS-C-7021 :B-10	High Ta=+120°C 5°C Test Time=1,000hrs	0/22
Low Temperature Storage	JIS-C-7021 :B-12	Low Ta=-40°C 5°C Test Time=1,000hrs	0/22

*Failure Criteria:

1. VF arise \geq 10%
2. IV decline \geq 30%
3. A failure is an LED that is open or shorted

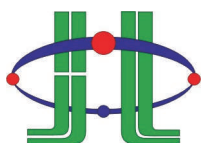

HUEY JANN ELECTRONICS INDUSTRY CO., LTD.

No.27 Line 466 Sec.2,Canng-nan Rd. Wu-chi Town Taichung Shien, Taiwan, R.O.C.

TEL:+886-4-26393976 FAX:+886-4-26393125

RELIABILITY TEST

➤ Environmental Test

Test Item	Reference Standard	Test Conditions	Result
Temperature Cycling	MIL-STD-202:107D MIL-STD-750:1051 MIL-STD-883:1010 JIS-C-7021 :A-4	-40°C ~ +25°C ~ +85°C ~ +25°C 60min 20min 60min 20min Test Time=200cycle	0/22
Thermal Shock	MIL-STD-202:107D MIL-STD-750:1051 MIL-STD-883:1010	-40°C 5°C ~ +110°C 5°C 20min 20min Test Time=200cycle	0/22

*Failure Criteria:

1. VF arise \geq 10%
2. IV decline \geq 30%
3. A failure is an LED that is open or shorted

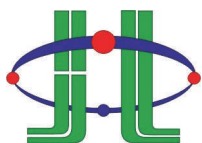

HUEY JANN ELECTRONICS INDUSTRY CO., LTD.

No.27 Line 466 Sec.2,Canng-nan Rd. Wu-chi Town Taichung Shien, Taiwan, R.O.C.

TEL:+886-4-26393976 FAX:+886-4-26393125

TYPICAL ELECTRICAL OPTICAL CHARACTERISTICS CURVES

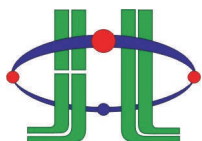
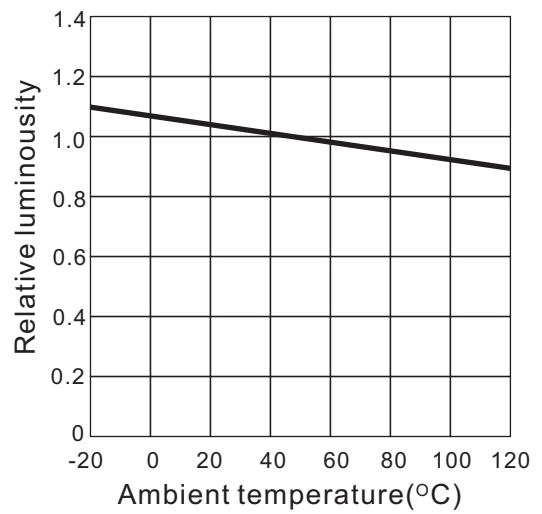
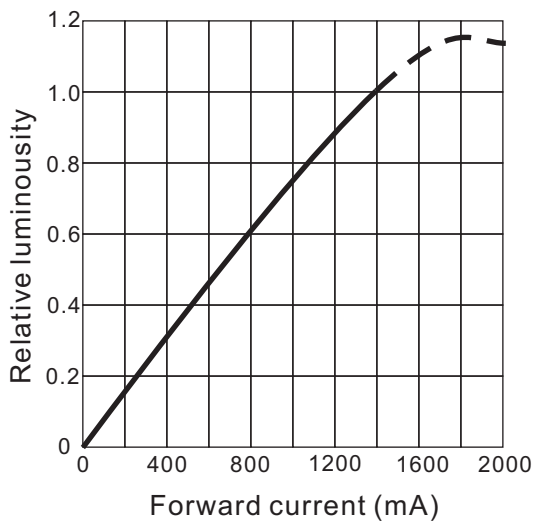
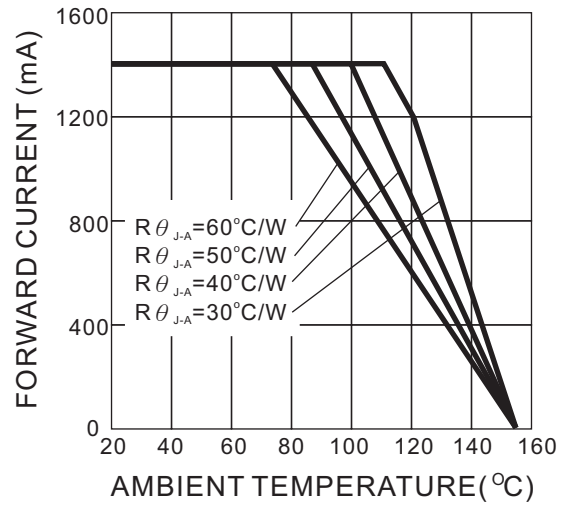
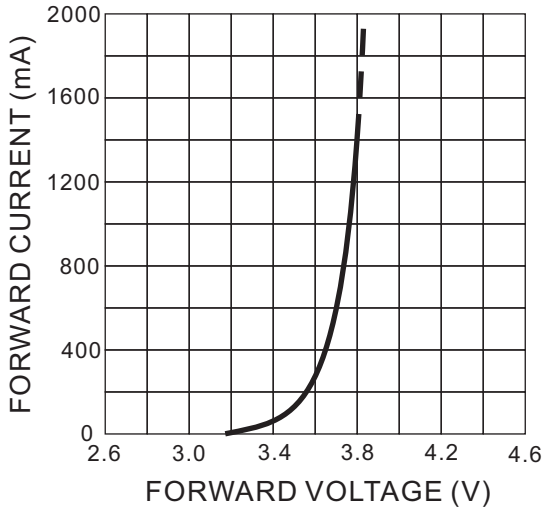

HUEY JANN ELECTRONICS INDUSTRY CO., LTD.

No.27 Line 466 Sec.2,Cannng-nan Rd. Wu-chi Town Taichung Shien, Taiwan, R.O.C.

TEL:+886-4-26393976 FAX:+886-4-26393125

TYPICAL ELECTRICAL OPTICAL CHARACTERISTICS CURVES

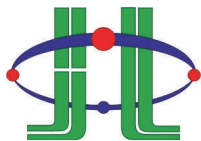
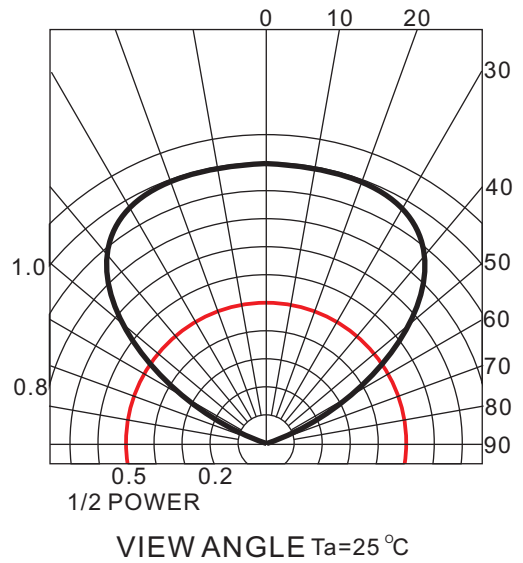
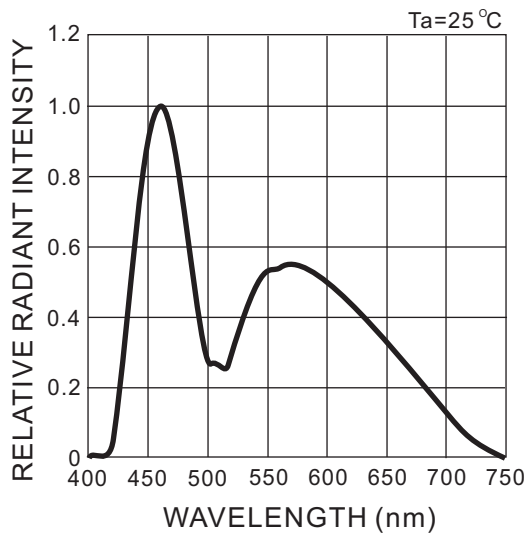
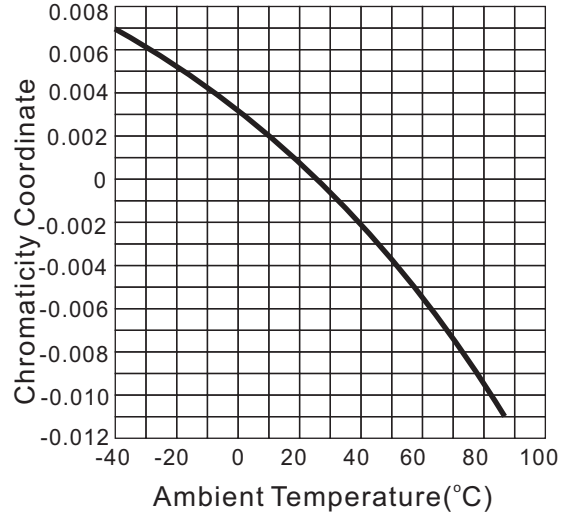
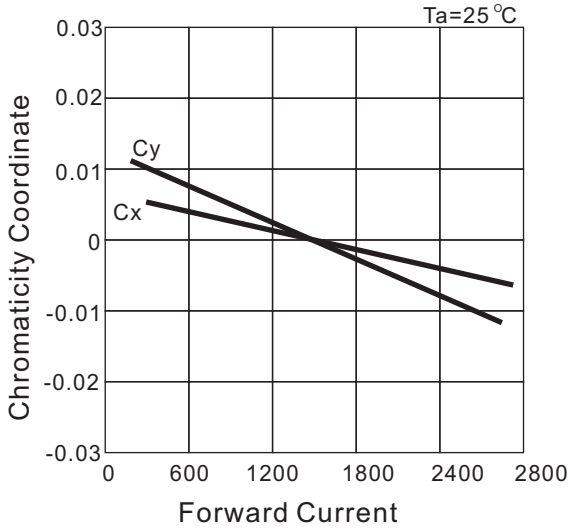

HUEY JANN ELECTRONICS INDUSTRY CO., LTD.

No.27 Line 466 Sec.2,Canng-nan Rd. Wu-chi Town Taichung Shien, Taiwan, R.O.C.

TEL:+886-4-26393976 FAX:+886-4-26393125

Brightness Bin Selection

Brightness Code		
BIN CODE	Brightness in lm	
	Minimum	Maximum
Q	240	310

NOTE:

- 1. Test Condition at IF=1400mA.
- 2. Brightness tolerance for each bin limit is $\pm 15\%$

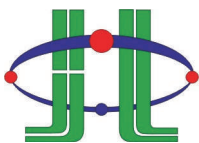

HUEY JANN ELECTRONICS INDUSTRY CO., LTD.

No.27 Line 466 Sec.2,Canng-nan Rd. Wu-chi Town Taichung Shien, Taiwan, R.O.C.

TEL:+886-4-26393976 FAX:+886-4-26393125

Pure White Color Bin Selection

Bin	CCT(°K)	Chromaticity Coordinates				
	TYP					
T1	9000	x	0.274	0.292	0.299	0.283
		y	0.301	0.322	0.300	0.284
T2	9000	x	0.283	0.299	0.303	0.290
		y	0.284	0.300	0.283	0.270
T3	8000	x	0.292	0.303	0.308	0.299
		y	0.322	0.333	0.311	0.300
T4	8000	x	0.299	0.308	0.311	0.303
		y	0.300	0.311	0.293	0.283
T5	6700	x	0.301	0.314	0.316	0.305
		y	0.342	0.355	0.333	0.322
T6	6700	x	0.305	0.316	0.317	0.308
		y	0.322	0.333	0.320	0.311
T7	6700	x	0.308	0.317	0.319	0.311
		y	0.311	0.320	0.300	0.293
T8	6000	x	0.314	0.329	0.329	0.316
		y	0.355	0.369	0.345	0.333
T9	6000	x	0.316	0.329	0.329	0.317
		y	0.333	0.345	0.331	0.320
T10	6000	x	0.317	0.329	0.329	0.319
		y	0.320	0.331	0.310	0.300
T11	5300	x	0.329	0.348	0.346	0.329
		y	0.369	0.385	0.359	0.345
T12	5300	x	0.329	0.346	0.329	0.344
		y	0.345	0.359	0.331	0.344
T13	5300	x	0.344	0.329	0.343	0.329
		y	0.344	0.331	0.331	0.320
T14	4750	x	0.348	0.367	0.362	0.346
		y	0.385	0.400	0.372	0.359
T15	4750	x	0.346	0.362	0.360	0.344
		y	0.359	0.372	0.357	0.344
Tolerance			x ± 0.02		y ± 0.02	

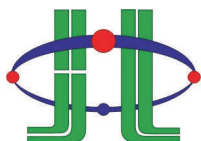

HUEY JANN ELECTRONICS INDUSTRY CO., LTD.

No.27 Line 466 Sec.2,Cannng-nan Rd. Wu-chi Town Taichung Shien, Taiwan, R.O.C.

TEL:+886-4-26393976 FAX:+886-4-26393125

Pure White Color Bin Selection

CIE Light Color Chart

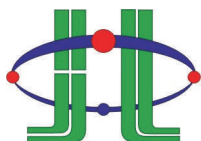
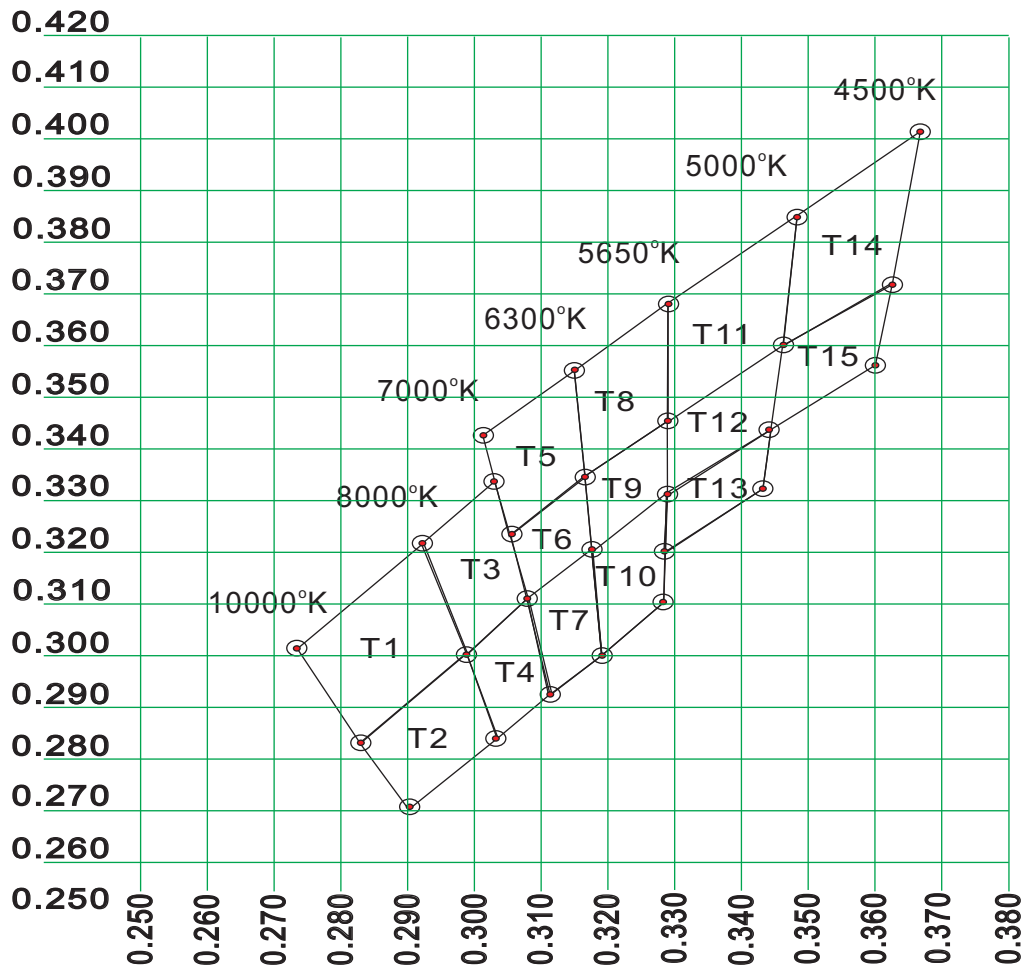

HUEY JANN ELECTRONICS INDUSTRY CO., LTD.

No.27 Line 466 Sec.2, Cangg-nan Rd. Wu-chi Town Taichung Shien, Taiwan, R.O.C.

TEL:+886-4-26393976 FAX:+886-4-26393125

Nature White Color Bin Selection

Bin	CCT(°K)	Chromaticity Coordinates				
	TYP					
N1	4300	x	0.367	0.385	0.381	0.364
		y	0.400	0.412	0.393	0.382
N2	4300	x	0.364	0.381	0.378	0.362
		y	0.382	0.393	0.382	0.371
N3	4300	x	0.362	0.378	0.374	0.359
		y	0.371	0.382	0.365	0.355
N4	4300	x	0.359	0.374	0.370	0.357
		y	0.355	0.365	0.351	0.342
N5	3950	x	0.385	0.402	0.396	0.381
		y	0.412	0.422	0.403	0.393
N6	3950	x	0.381	0.396	0.392	0.378
		y	0.393	0.403	0.390	0.382
N7	3950	x	0.378	0.392	0.387	0.374
		y	0.382	0.390	0.373	0.365
N8	3950	x	0.370	0.387	0.382	0.357
		y	0.351	0.373	0.359	0.342
N9	3650	x	0.402	0.420	0.414	0.396
		y	0.422	0.432	0.416	0.403
N10	3650	x	0.396	0.414	0.408	0.392
		y	0.403	0.416	0.399	0.390
N11	3650	x	0.392	0.408	0.402	0.387
		y	0.390	0.399	0.382	0.373
N12	3650	x	0.387	0.402	0.396	0.382
		y	0.373	0.382	0.367	0.359
Tolerance			x ± 0.02		y ± 0.02	

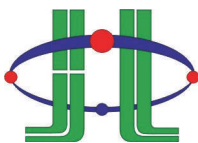

HUEY JANN ELECTRONICS INDUSTRY CO., LTD.

No.27 Line 466 Sec.2,Cannng-nan Rd. Wu-chi Town Taichung Shien, Taiwan, R.O.C.

TEL:+886-4-26393976 FAX:+886-4-26393125

☰ Nature White Color Bin Selection

➤ CIE Light Color Chart

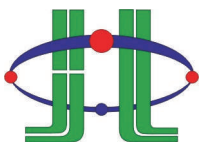
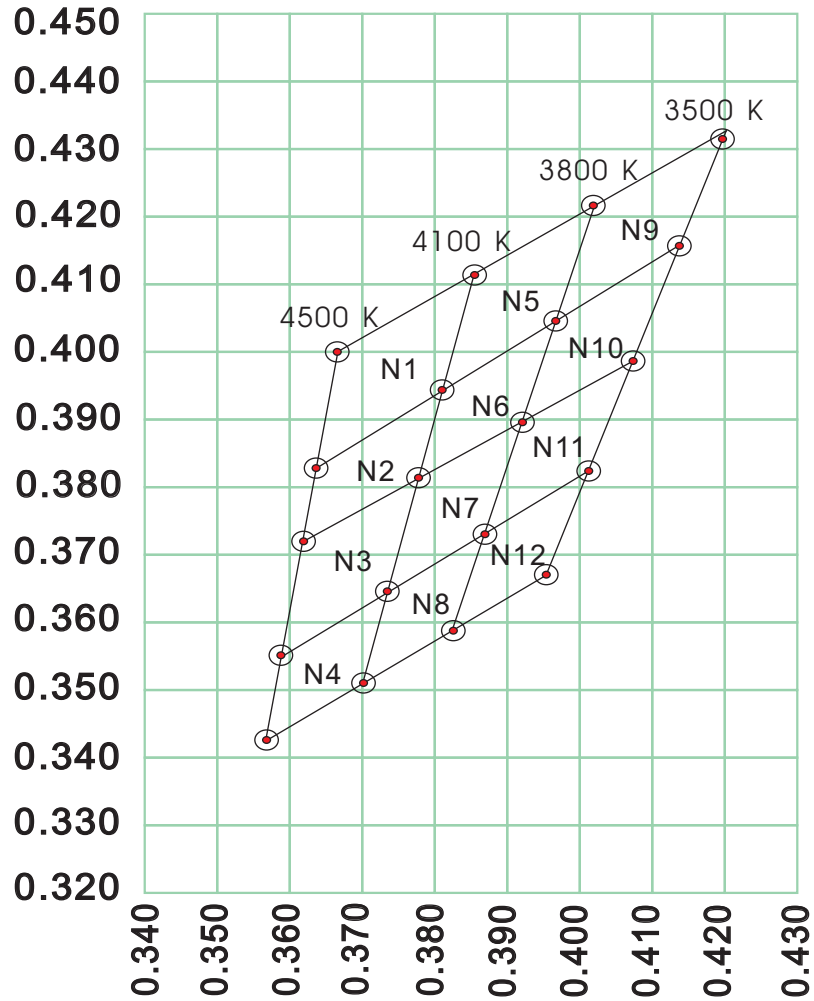

HUEY JANN ELECTRONICS INDUSTRY CO., LTD.

No.27 Line 466 Sec.2,Canng-nan Rd. Wu-chi Town Taichung Shien, Taiwan, R.O.C.

TEL:+886-4-26393976 FAX:+886-4-26393125

Warm White Color Bin Selection

Bin	CCT(°K)	Chromaticity Coordinates				
	TYP					
C10	3640	x	0.402	0.417	0.409	0.392
		y	0.423	0.431	0.400	0.391
C11	3500	x	0.402	0.438	0.424	0.392
		y	0.423	0.440	0.406	0.391
C12	3640	x	0.392	0.409	0.402	0.387
		y	0.391	0.400	0.382	0.374
C13	3370	x	0.409	0.424	0.416	0.402
		y	0.400	0.406	0.389	0.382
C14	3500	x	0.387	0.416	0.410	0.383
		y	0.374	0.389	0.374	0.360
C15	3150	x	0.438	0.454	0.438	0.424
		y	0.440	0.446	0.412	0.406
C16	3150	x	0.424	0.438	0.429	0.416
		y	0.406	0.412	0.394	0.389
C17	2950	x	0.454	0.471	0.453	0.438
		y	0.446	0.451	0.416	0.412
C18	2950	x	0.438	0.453	0.444	0.429
		y	0.412	0.416	0.399	0.394
Tolerance			x ± 0.02		y ± 0.02	

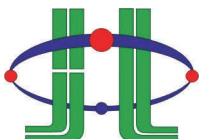

HUEY JANN ELECTRONICS INDUSTRY CO., LTD.

No.27 Line 466 Sec.2,Canng-nan Rd. Wu-chi Town Taichung Shien, Taiwan, R.O.C.

TEL:+886-4-26393976 FAX:+886-4-26393125

Warm White Color Bin Selection

➤ CIE Light Color Chart

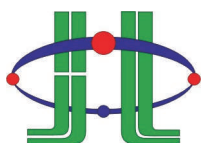
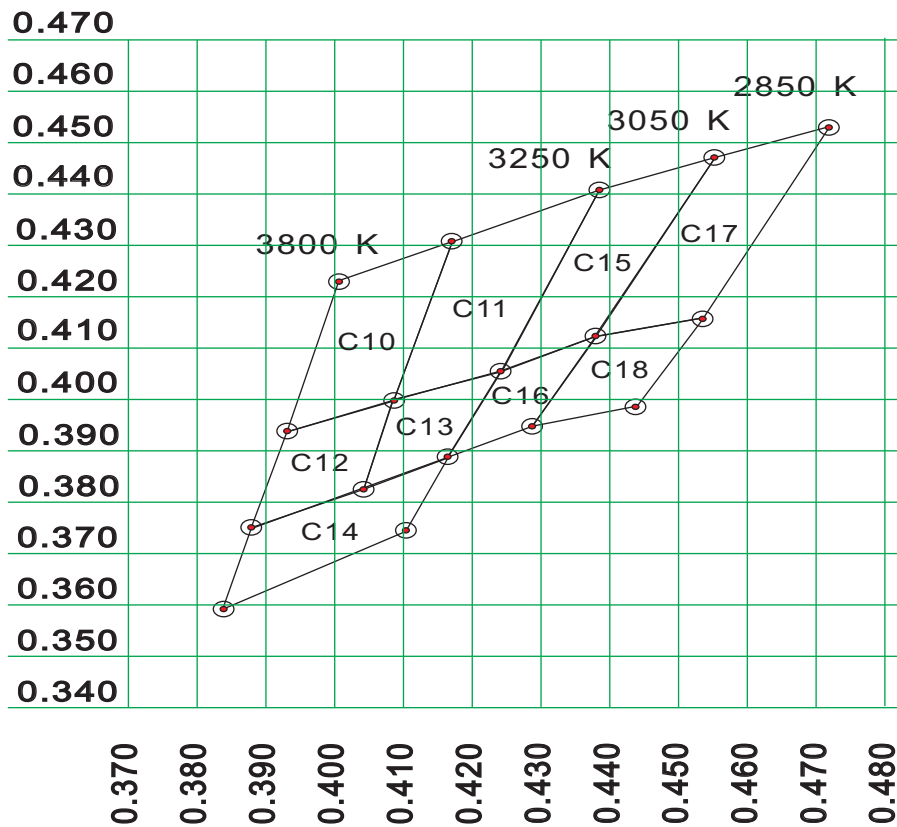

HUEY JANN ELECTRONICS INDUSTRY CO., LTD.

No.27 Line 466 Sec.2,Canng-nan Rd. Wu-chi Town Taichung Shien, Taiwan, R.O.C.

TEL:+886-4-26393976 FAX:+886-4-26393125

Package Dimension For Emitter Type

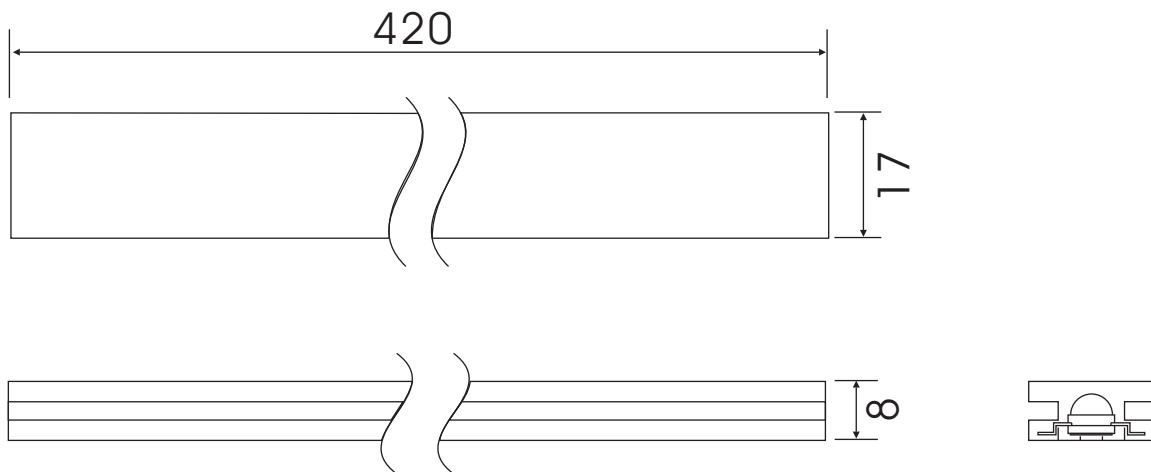

NOTE:

1. Dimensions are specified as follows: mm.
2. Tolerance is 0.3mm unless otherwise noted.
3. 50 pcs emitters per tube.
4. 80 tubes per inside box.
5. 4 inside box per outside box.

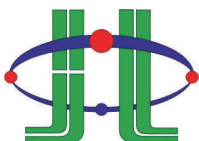

HUEY JANN ELECTRONICS INDUSTRY CO., LTD.

No.27 Line 466 Sec.2,Canng-nan Rd. Wu-chi Town Taichung Shien, Taiwan, R.O.C.

TEL:+886-4-26393976 FAX:+886-4-26393125

Package Dimension For Emitter Type Tapping Reel

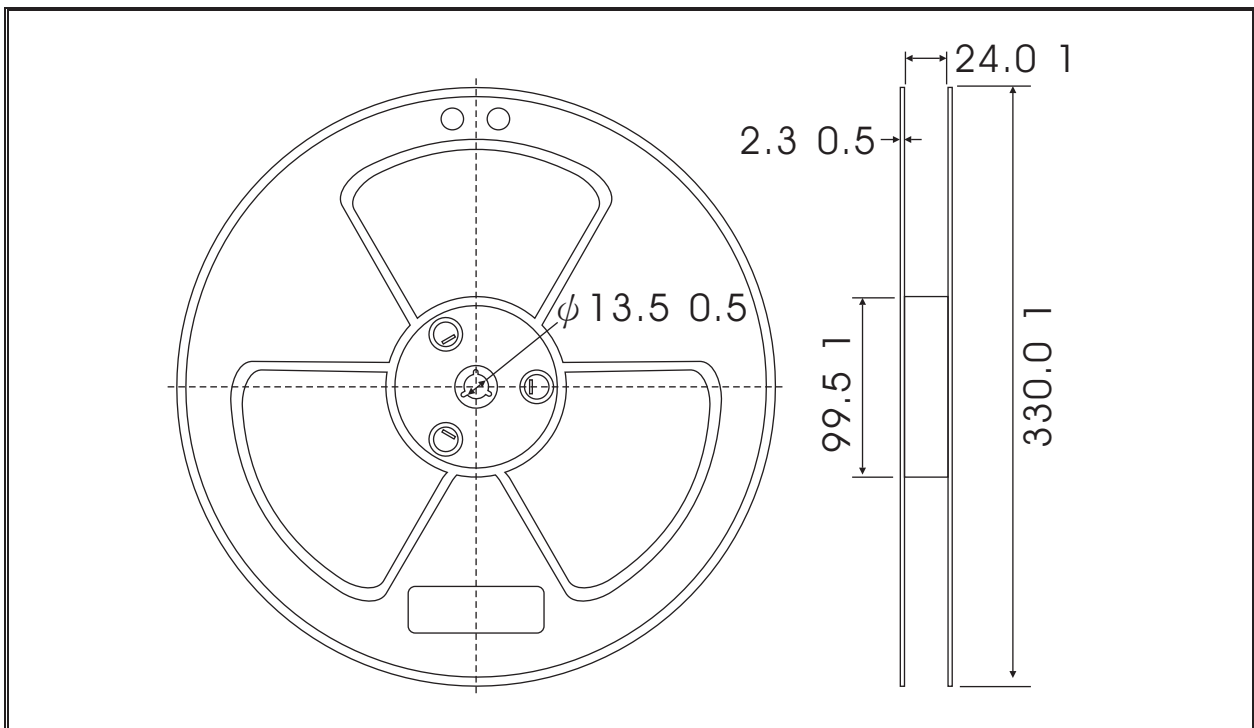
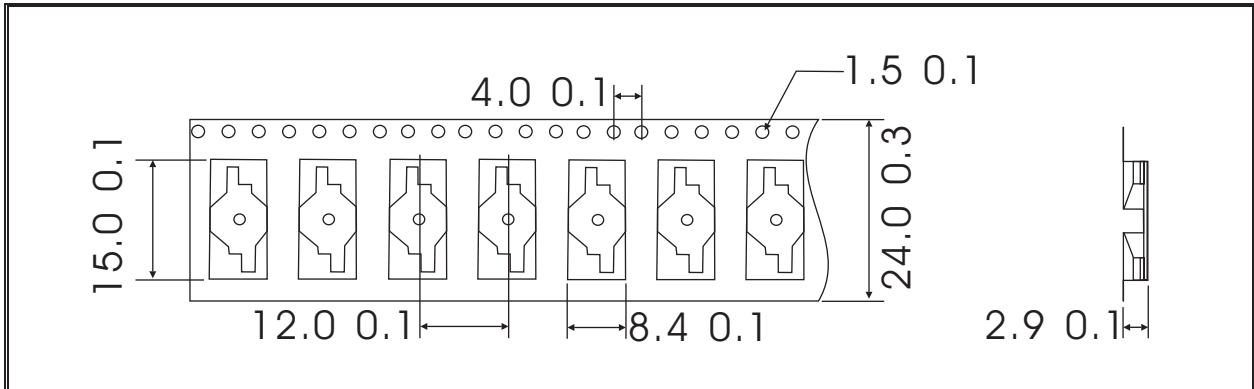

NOTE:

1. Dimensions are specified as follows: mm.
2. Tolerance is 0.3mm unless otherwise noted.
3. 900pcs emitters per Tapping Reel.

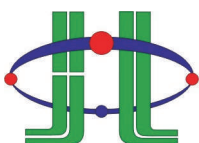

HUEY JANN ELECTRONICS INDUSTRY CO., LTD.

No.27 Line 466 Sec.2,Canng-nan Rd. Wu-chi Town Taichung Shien, Taiwan, R.O.C.

TEL:+886-4-26393976 FAX:+886-4-26393125

Package Dimension For Star Type

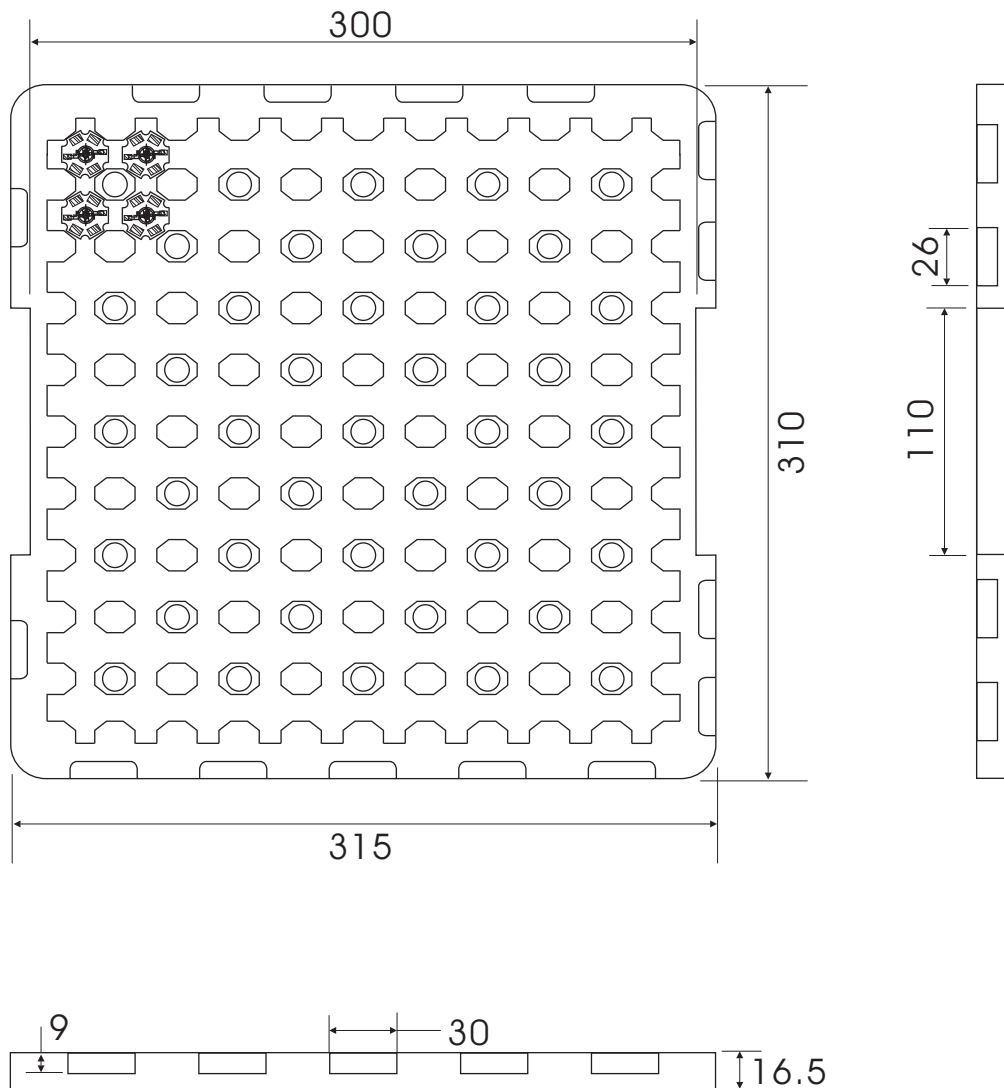

NOTE:

1. Dimensions are specified as follows: mm.
2. Tolerance is 0.3mm unless otherwise noted.
3. 100pcs star per tray.
4. 10 trays per box.

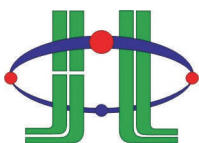

HUEY JANN ELECTRONICS INDUSTRY CO., LTD.

No.27 Line 466 Sec.2,Canng-nan Rd. Wu-chi Town Taichung Shien, Taiwan, R.O.C.

TEL:+886-4-26393976 FAX:+886-4-26393125

Requirements to user For Emitter Type

The LED products by HUEY-JANN is designed, manufactured, and sold aiming at high standard quality and reliability, however, reliability of electronic apparatus is seen as a product of reliability superior to HUEY-JANN and using status at users. From this point, HUEY-JANN requests user's for following things.

Please do not extrude the colloid

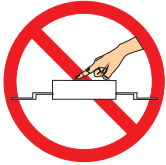

Recommended Solder Pad Design For Emitter Type

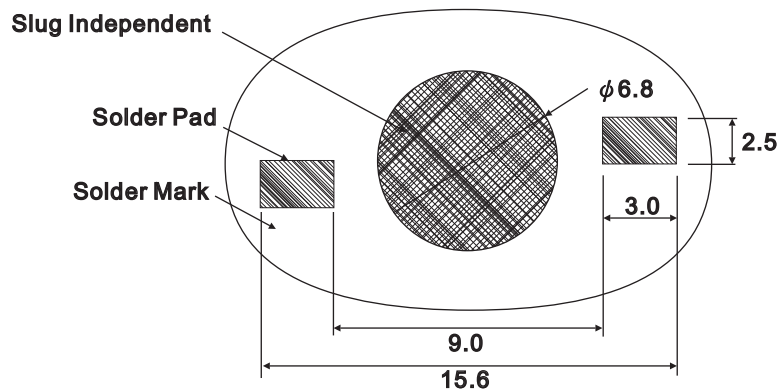

Note:

- 1.All dimensions are in millimeters.
- 2.Electrical isolation is required between Slug and Solder Pad.

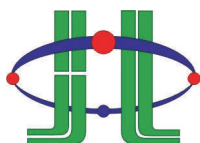

HUEY JANN ELECTRONICS INDUSTRY CO., LTD.

No.27 Line 466 Sec.2,Cannng-nan Rd. Wu-chi Town Taichung Shien, Taiwan, R.O.C.

TEL:+886-4-26393976 FAX:+886-4-26393125

Heat Plate Soldering Condition For Emitter Type

a. Soldering Process for Solder Paste

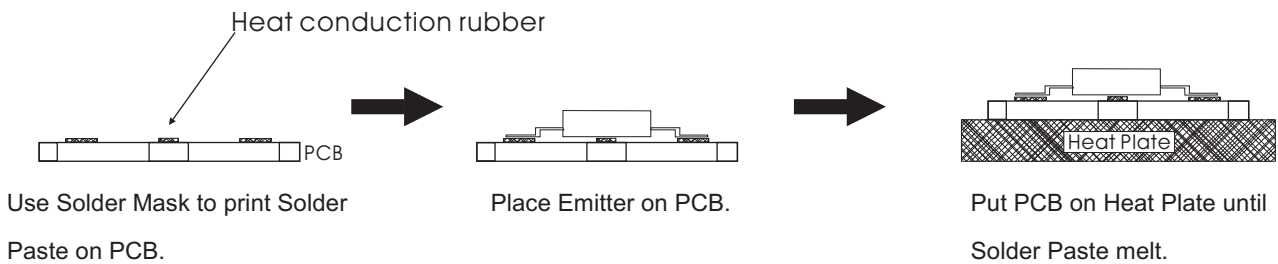

- 1.The Solder Paste could be melted within 10 seconds.
- 2.Take out PCB out from Heat Plate within 15 seconds.

b. Soldering Process for Solder Wire

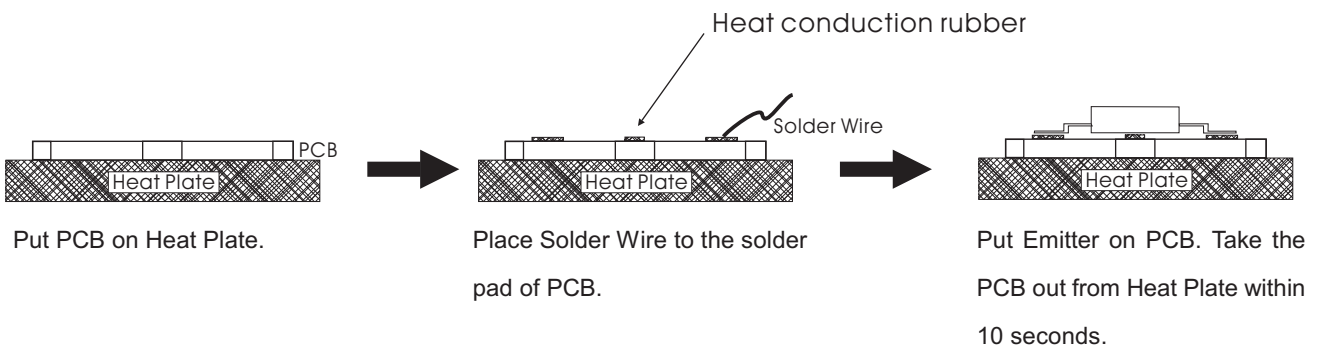

NOTE:

- 1.Heat plate temperature: 230°C max for Lead Solder and 260 °C max for Lead-Free Solder.
- 2.When soldering, do not put stress on the LEDs during heating.
- 3.After soldering, do not warp the circuit board.

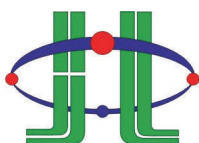

HUEY JANN ELECTRONICS INDUSTRY CO., LTD.

No.27 Line 466 Sec.2,Canng-nan Rd. Wu-chi Town Taichung Shien, Taiwan, R.O.C.

TEL:+886-4-26393976 FAX:+886-4-26393125

Soldering Process For Hot Bar For Emitter Type

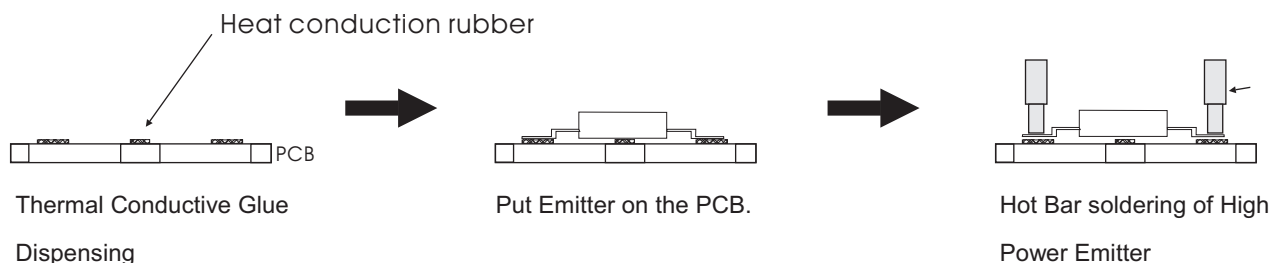

NOTE:

- 1.Hot Bar temperature: 230°C max for Lead Solder and 260°C max for Lead-Free Solder.
- 2.When soldering, do not put stress on the LEDs during heating.
- 3.After soldering, do not warp the circuit board.

Manual Hand Soldering For Emitter Type

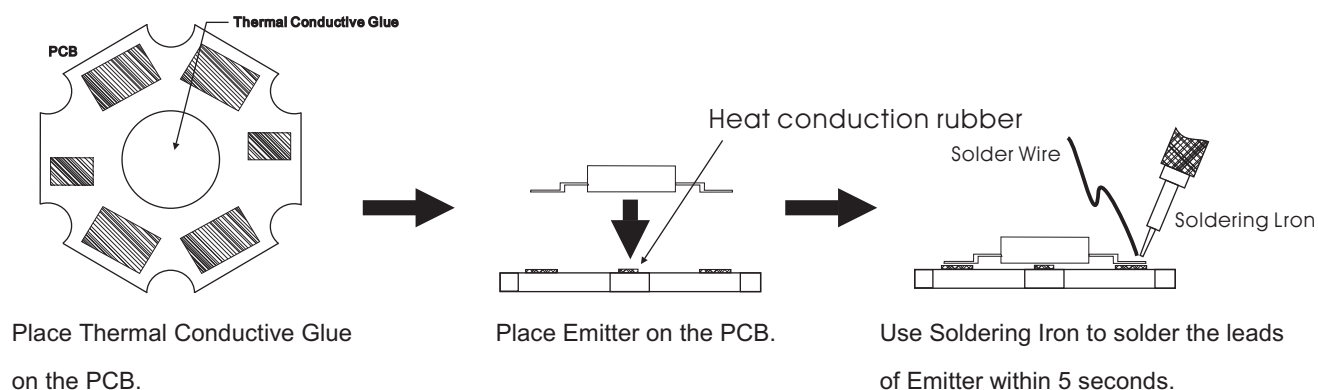

- 1.Solder tip temperature: 230°C max for Lead Solder and 260°C max for Lead-Free Solder.
- 2.Avoiding damage to the emitter or to the PCB dielectric layer. Damage to the epoxy layer can cause
- 3.Do not let the solder contact from solder pad to back-side of PCB. This one will cause a short circuit and damage emitter.

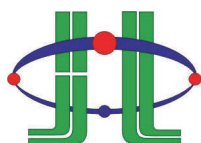

HUEY JANN ELECTRONICS INDUSTRY CO., LTD.

No.27 Line 466 Sec.2,Cannng-nan Rd. Wu-chi Town Taichung Shien, Taiwan, R.O.C.

TEL:+886-4-26393976 FAX:+886-4-26393125

Reflow Solder Condition For Emitter Type

Profile Feature	Sn-Pb Eutectic Assembly	Lead-Free Assembly
Average Ramp-Up Rate (T_{max} To T_p)	3 °C/sec max	3 °C/sec max
Average Ramp-Down Rate	6 °C/sec max	6 °C/sec max
Preheat Temperature Min Temperature Max Time	100 °C 150 °C 60-120sec	150 °C 200 °C 60-180sec
Time Maintained Above Temperature (T_L) Time Max	180 °C 150sec	210 °C 150sec
Peak Temperature (T_p)	240 °C	260 °C
Time Within 5°C of Actual Peak Temperature (t_p)	10 ~ 30sec	20 ~ 40sec

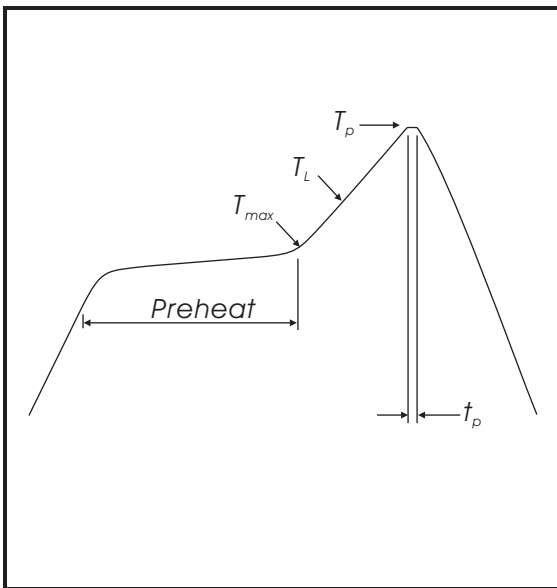

Note:

- 1.All temperature regarding topside of the package, measured on the package body surface.
- 2.After the LEDs have been soldered repairing should not be done. When repairing is unavoidable, a heat plate should be used. It should be confirmed beforehand whether the characteristics of LEDs will or will not be damaged by repairing.
- 3.Reflow soldering more than two times is not recommended.
- 4.While soldering do not put stress on the LEDs during heating.
- 5.After soldering do not warp the circuit board.

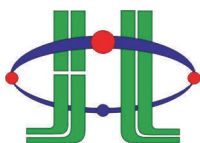



HUEY JANN ELECTRONICS INDUSTRY CO., LTD.

No.27 Line 466 Sec.2,Cannng-nan Rd. Wu-chi Town Taichung Shien, Taiwan, R.O.C.

TEL:+886-4-26393976 FAX:+886-4-26393125

Conclusion

Huey Jann provide simple comparison table for High Power LED, you could find your request heat dissipation area from the following table.

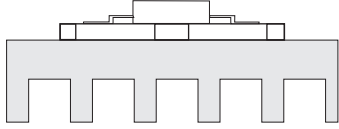
	 <p>Free Convection Horizontal Flat Heat Dissipation-Set-up (Area Require mm²)</p>	 <p>Free Convection Vertical Flat Heat Dissipation-Set-up (Area Require mm²)</p>	 <p>Free Convection Finned Heat Dissipation-Set-up (Area Require mm²)</p>
5W	9,000	7,500	12,000

*TAB in this table is according to highest operating temperature 65°C.

*Different materials of second heat dissipation device, the surface area of heat sink will be different. Thus, this document is for reference only.

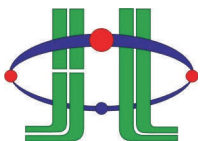

HUEY JANN ELECTRONICS INDUSTRY CO., LTD.

No.27 Line 466 Sec.2,Cannng-nan Rd. Wu-chi Town Taichung Shien, Taiwan, R.O.C.

TEL:+886-4-26393976 FAX:+886-4-26393125

TAB Temperature - Life Characteristics Curves

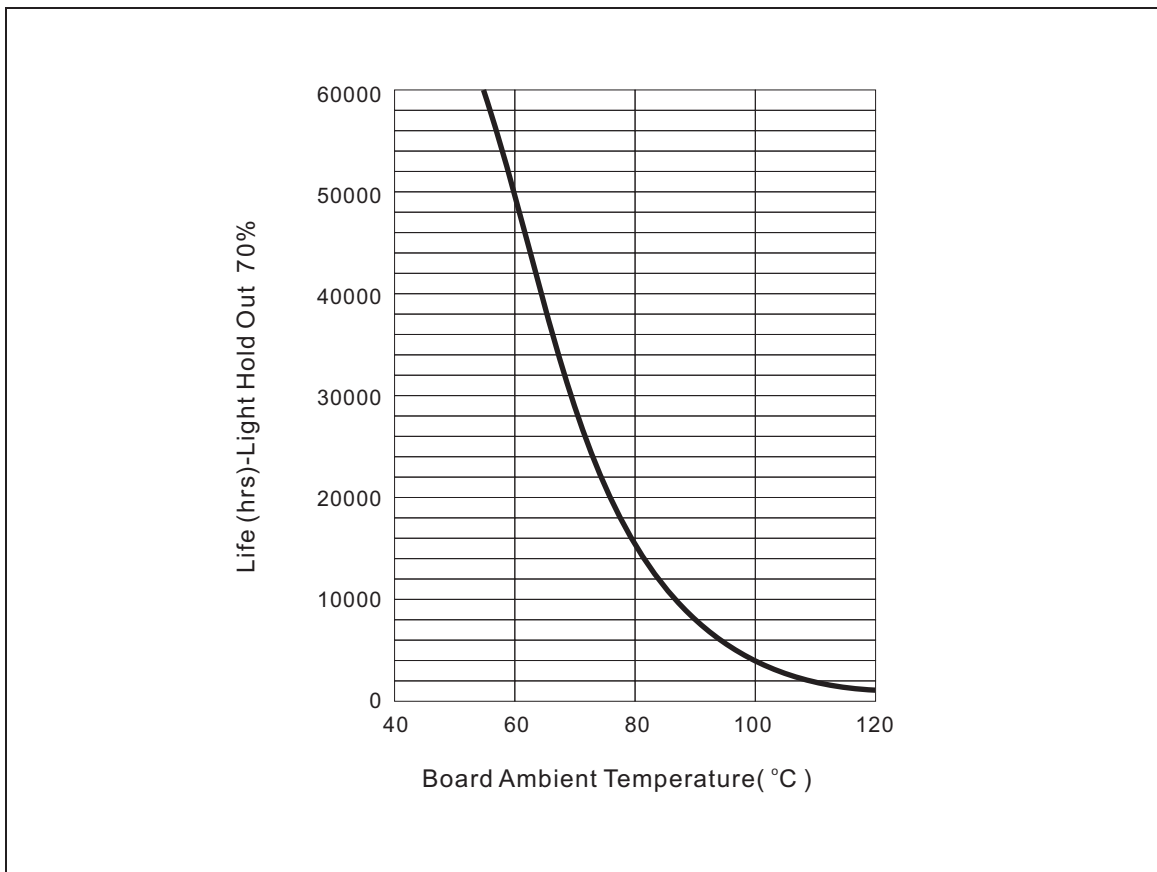
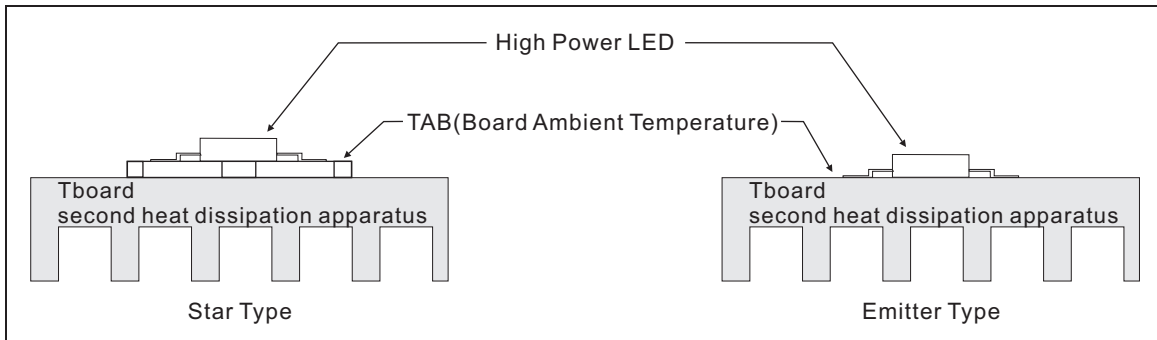

*Board Ambient Temperature Tolerance 5°C.

*The TAB is the stable testing value for the product lighted 100% after one hour.

*This document is for reference only.

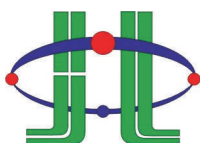

HUEY JANN ELECTRONICS INDUSTRY CO., LTD.

No.27 Line 466 Sec.2,Cannng-nan Rd. Wu-chi Town Taichung Shien, Taiwan, R.O.C.

TEL:+886-4-26393976 FAX:+886-4-26393125