



1W HIGH POWER LED

OF-HPXX-1XX



ATTENTION
OBSERVE PRECAUTIONS
FOR HANDLING
ELECTROSTATIC
DISCHARGE
SENSITIVE
DEVICES



■ Features

- Highest flux
- Long operating life
- Wide range of colors: White, Green, Blue, Cyan, Red and Yellow
- Lambertian, Batwing or Side Emitting radiation pattern
- More energy efficient than incandescent and most halogen lamps
- Low voltage DC operated
- Cool beam, safe to the touch
- Instant light (less than 100ns)
- Fully dimmable
- No UV
- Superior ESD protection
- Eutectic die bonding, lower R_{th}
- RoHS compliant

■ Typical Applications

- Reading lights (car, bus, aircraft)
- Portable (flashlight, bicycle)
- Mini-accent/ Up lighters / Down lighters / Orientation
- Fiber optic alternative/ Decorative / Entertainment
- Bollards/Security/Garden
- Cove / Under shelf / Task
- Traffic signaling / Beacons / Rail Crossing and Wayside
- Indoor / Outdoor Commercial and Residential Architectural
- Automotive Exit (Stop-Tail-Turn, CHMSL, Mirror Side Repeat)
- Edge-lit signs (Exit, point of sale)
- LCD Backlights/light Guides

■ Mechanical Dimensions

- Lambertian

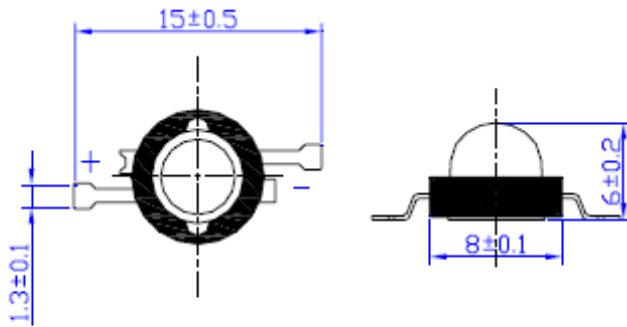

- Side Emitting

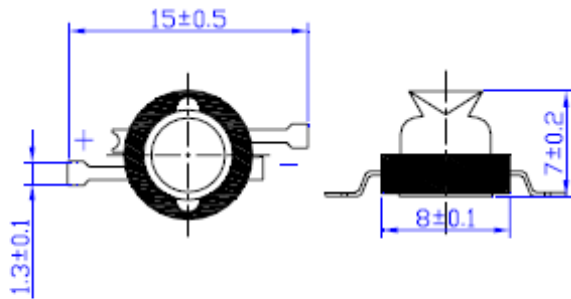

- Batwing

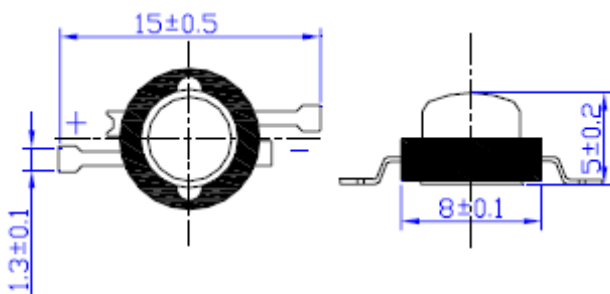

■ Radiation Pattern

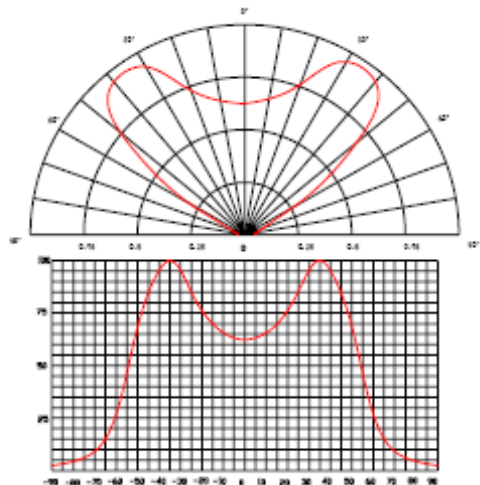
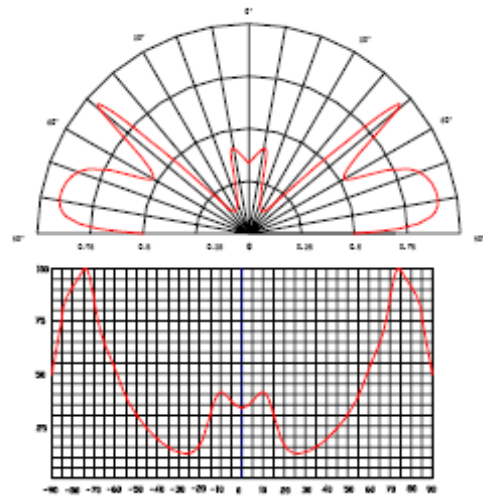
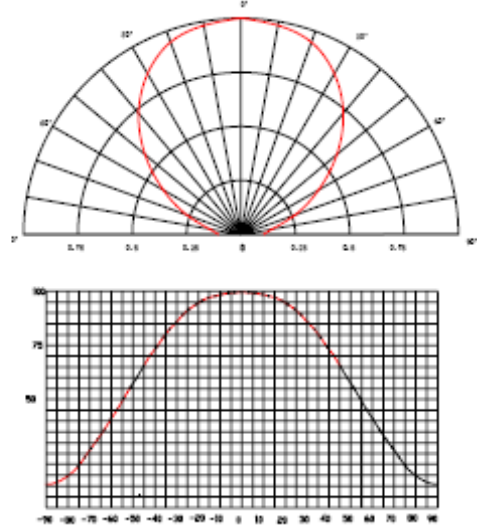



1W HIGH POWER LED

■ Optical Characteristics @ 350mA, T_j=25°C

Color	Part Number	Color Temperature	Viewing angle	Forward voltage [V]	Thermal resistance [°C/W]	Luminous flux φV(lm) (min-typ)	Radiation pattern
White	OF-HPW1-1EL	6000K	140°	3.6	13	35-45	Lambertian
	OF-HPW3-1EL	6000K	140°	3.4-3.6	13	45-55	Lambertian
	OF-HPW4-1EL	6000K	140°	3.1-3.5	10	55-65	Lambertian
Warm white	OF-HPWW1-1EL	3500K	140°	3.6	13	30-40	Lambertian
Red	OF-HPR1-1EL	625nm	140°	2.3-2.5	12	20-25	Lambertian
Blue	OF-HPB-1EL	470nm	140°	3.4-3.6	10	5-8	Lambertian
Green	OF-HPG-1EL	520nm	140°	3.4-3.6	10	35-50	Lambertian

■ Absolute Maximum Ratings

Item	Symbol	Absolute Maximum Rating	Unit
DC Forward Current	IF	350	mA
Peak Forward Current*	IFP	500	mA
Reverse Voltage	VR	5	V
Power Dissipation	PD	2000	V
Electrostatic Discharge	ESD	±4500	mW
Operating/Storage Temperature	Topr/Tstg	-40°C~+80°C / -40°C~+100°C	°C
Lead Soldering Temperature	Tsol	Max.260° for 6 seconds Max.	

NOTES:

* IFP Conditions: pulse Width≤10msec.

* All high power emitter LED products mounted on aluminum metal-core printed circuit board, can be lighted directly, but we do not recommend lighting the high power products for more than 5 seconds without a appropriate heat dissipation equipment.



1W HIGH POWER LED

■ Optical Electrical Characteristics

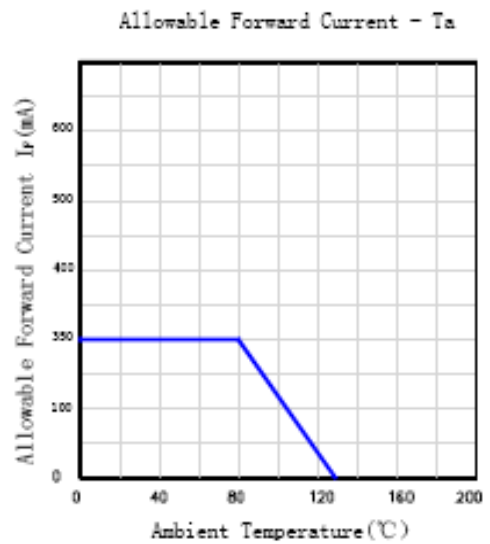
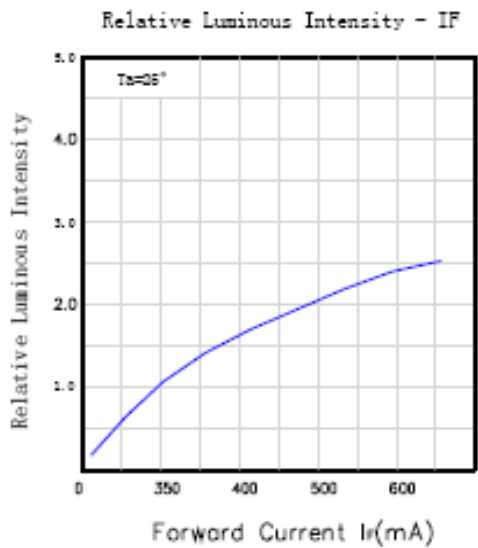
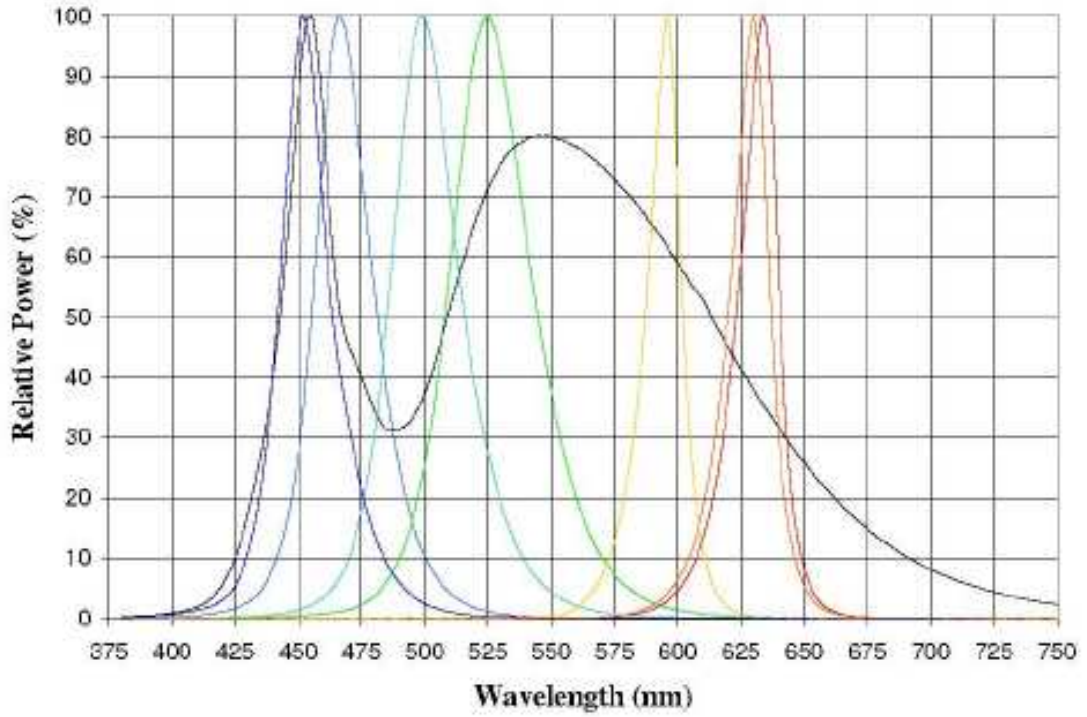



1W HIGH POWER LED

